

CC121, CC171, CC221, CC321

Cutting and Beveling Saws



Operating Instructions

CC121FS19, CC121FS15, GA10-1-120
CC171FS19, CC171FS15, GA10-1-170
CC221FS19, CC221FS15, GA10-1-220
CC321FS29, CC321FS15, GA10-1-320

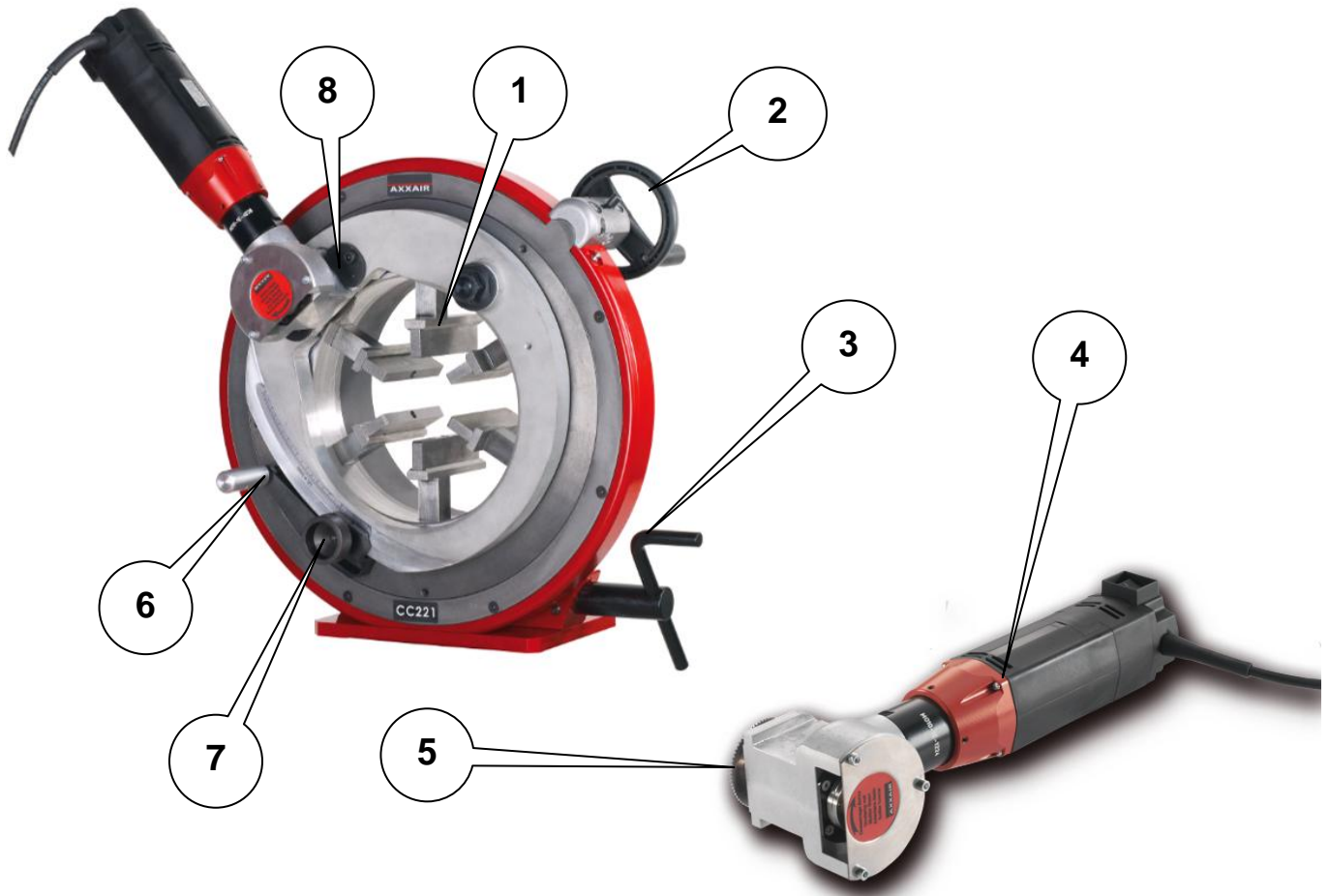

1	Clamping jaws
2	Wheel handle
3	Clamping handle
4	Cutting motor
5	Cutting blade
6	Penetration lever
7	ØAdjust screw
8	Mounting bracket for motor





88/392/EEG
 91/368/EEG
 M. LEGRAND
 AXXAIR Manager

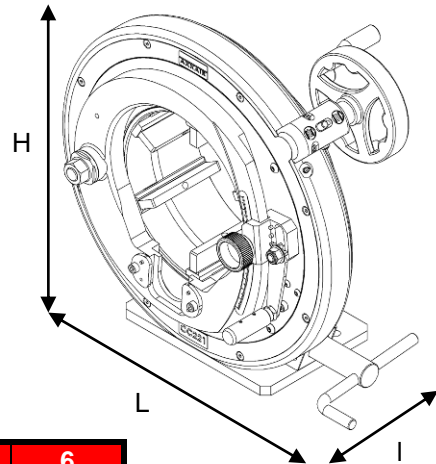

AXXAIR

	∅ min	∅ max	Ep mm	H x L x l Mm	
CC121	5 mm 1/16"	129 mm 4.5"	0.7 to 15	432x520x297	37 kg
CC171	16 mm 3/8"	170 mm 6"	0.7 to 15	474x545x297	44 kg
CC221	59 mm 2"	225 mm 8"	1 to 15	515x570x320	51 kg
CC321	138 mm 5"	330mm 12"	1.5 to 15	674x636x320	73 kg



	1	2	3	4	5	6
121FS29/FS19 171FS29/FS19 221FS29/FS19 321FS29/FS19	95 RPM	120 RPM	150 RPM	180 RPM	210 RPM	280 RPM
121FS25/FS15 171FS25/FS15 221FS25/FS15 321FS25/FS15	30 RPM	38 RPM	47 RPM	56 RPM	65 RPM	75 RPM
	79 dB	82 dB	85 dB	87 dB	89 dB	90 dB
	Vibration level in accordance with DIN EN 28662 :					
	Protection class : IP 20					

	0.3 MPa	0.4 MPa	0.5 MPa	0.6 MPa
121PD 171PD 221PD 321PD	60 RPM	72 RPM	85 RPM	110 RPM
	90 dB	92 dB	93 dB	95 dB



Operating Instructions :

Safety instructions :

WARNING! In order to reduce all risks of possible body harm when using electric equipment. PLEASE READ THESE INSTRUCTIONS THOROUGHLY BEFORE USING THE MACHINES. Keep these safety instructions.

The machine must only be used by qualified technicians who have been trained to use the equipment. This machine should be used only for the job for which it was designed. Keep your working area tidy. Untidiness increases the risks of accidents. Consider the work area environment in which you use the equipment. Do not expose the electric tools to the rain. Do not use them in a humid or wet environment or in the presence of inflammable gases or liquids. Always work in a well-lit place. Protect yourself against electric shocks. Avoid being in touch with areas related to the ground. When not in use, tools should be stored in a dry, secure place. Dress properly with clothes adapted for the job. Do not wear loose clothing or jewellery. They could be caught up in moving parts. Use the safety glasses provided with the machine. You can also use a face or dust mask if the cutting operation is dusty. Do not abuse the cable. Never carry the machine by the cable or yank it to disconnect from plug. Keep the cable away from heat, oil and sharp objects. Inspect cable regularly and if damaged, have it repaired by authorised after-service facility. Secure the machine on a workbench or into the ground via the security leg in order to work safely. Maintain tools with care. Keep the machine clean for a better and safer performance. Follow instructions for lubricating and changing accessories. Unplug the machine when not in use, before maintaining, and when changing accessories (e.g. blades). Avoid unintentional starting. Do not carry plugged-in tool with finger on switch. Be sure the switch is off when plugging in. Use appropriate extension cords. When using the machine outdoor, use only extension cords intended for outdoor use. Stay alert. Watch what you are doing. Use common sense. Do not operate tool when you are tired. Check if your machine is damaged. Before using the machine ALWAYS check that no parts have been damaged in order to be sure that it can perform its intended function. Check for alignment of moving parts, binding of moving parts, breakage of parts, mounting, and any other conditions that may affect its operation. Damaged parts should be properly repaired or replaced by an authorised after-service centre. **DO NOT USE MACHINE IF DAMAGED.** Use AXXAIR accessories only. Repairing by experts only. The machine is in accordance with the relevant safety rules. If you are using an electric motor make sure that the voltage is the appropriate. If you are using a pneumatic motor, check the pressure of the compressed air (6 bars). Output: see relevant chapter. The use of an oil filter is MANDATORY; you can obtain it on request. Always check that the handle and the safety pedal has been provided with the machine.(for a pneumatic machine only). Use appropriate means for handling the machine.

Contents:

Safety instructions
Contents

1. Declaration of Conformity
2. Machine usage
3. Receiving the machine
4. Handling the machines
5. Mounting on a workbench
6. Cutting tools
7. Installing the tool on the motor
8. Installing the motor on the machine
9. Cutting parameters
10. The tube's fastening
11. Additional clamping jaws
12. Penetration adjustments
13. Cutting step by step
14. Lubricants
15. Maintenance and Repairs
16. Environmental protection

1. Declaration of Conformity:

We declare under our own responsibility that this product conforms to the norms and guidelines indicated on page 2.

2. Machine usage:

This machine is the ideal answer for optimal preparation of welded tubes and other types of assemblies in the food industry, pharmaceutical, chemical fields, etc.

This procedure provides a rake face with a surface in a very good state and with very limited burring. The perpendicularity between the sheered surface and the tube is just tenths of a millimetre.

With a blade in good condition and adequate cutting parameters, the cut is considered to be without burrs.

3. Receiving the machine:

Machines are delivered in transport cases as specified in norm NIMP15. In the case you will find the machine bolted down and a bag containing the cutter's motor with the necessary accessories for using the machine.

**4. Handling the machines:**

Turn back the clamping jaws to their full extent. Sling the machine by its central opening in order to balance it.

Machines weigh between 37 and 73 kilograms depending on the model, so their handling requires the usual care and equipment.



5. Mounting on a workbench:

The cutting machine can be installed and bolted on a workbench. Attention should be paid to the stability of the assembly (cutting machine + workbench + the tube to be cut), and also to the load that can be supported by the workbench.

Weight of the tubes			
Material	Ext Ø	Thickness	Weight / m
Steel/Stainless	114.3 mm	15 mm	37 kg
Steel/Stainless	168.3 mm	15 mm	57 kg
Steel/Stainless	219.1 mm	15 mm	76 kg
Steel/Stainless	323.9 mm	15 mm	115 kg

For some models, foot supports can be supplied as an option.

6. Cutting tools:

When the machine is delivered, a blade is installed on the cutting motor. You should check that it corresponds to the tube you wish to cut.

WARNING: It is imperative that the cutting motor be disconnected from the power supply before any handling of the motor or the cutting tool.

AXXAIR saw blades are designed specially for your orbital cutting operations. They are made from high quality steels for optimal longevity. They adapt to all types of materials currently used.

The thickness of the tube being cut determines the choice of blade to be used.

Reference:	Thickness to be cut:
LS63128	0.5 to 0.7 mm
LS63100	0.7 to 1.5 mm
LS6364	1.0 to 3.0 mm
LS6872	1.0 to 3.0 mm
LS6844	2.0 to 7.0 mm
LS8080	1.0 to 3.0 mm
LS8054	2.0 to 7.0 mm
LS8034	5.0 to 12.0 mm
LS9038	5.0 to 15 mm

Blades with large teeth are always preferable when the thickness to be cut is at the limit of the capacity shown above.



The arrow indicates the tool's direction of rotation.

The hole positions the cutter and avoids all excessive clamping during usage.

7. Installing the tool on the motor:

WARNING: The motor should always be disconnected from the power supply.

These tools are sharp; appropriate gloves should therefore be used when installing and uninstalling the cutting tools.

Note: All support surfaces should always be cleaned.

- Place the blade in such a way that the **direction of rotation shown on the tool corresponds to the direction of rotation of the cutter's motor**. With this type of tool we always counterwork, i.e. the direction of rotation of the tool is the opposite to the direction of rotation of the forward motion.

- Place the disc over the blade, ensuring that the pin is correctly positioned.

Note: The pin is not a driving bolt; it's used to prevent the blade from over-tightening during usage and to allow easy uninstalling and changing of the blade.

- If the cutting tool used does not have a hole, mount the support disc with the pin toward the exterior.

- Put the nut in place and tighten with the key provided for that purpose. It needs to be tightened hard (by tapping the key) to keep the tool from loosening.

Note: The brass nut (yellow) tightens counter clockwise, the direction of tightening and loosening is therefore reversed in comparison to a normal thread.

On our cutting heads, we can install a two-sided tool with an angle head. It is strongly recommended that the machine be used with the tool installed as close as possible to the clamping jaws in order to limit vibration and thus lengthen the life of the tools. Exterior installation allows trimming the elbow joints and other joints after a faulty soldering at the tip of the tube.



Tool installation near the jaws



Exterior tool installation

8. Installing the motor on the machine:

WARNING: Clean all support surfaces well before installing the cutting head on the motor's supporting plate. Using the brush provided, clean the surface of the tool supporting plate as well as those of the cutting heads. The quality of the cuts depends on the geometry of these support surfaces.

- The motor is installed on the tool supporting plate by sliding it into the slot provided for that purpose.
- The motor's positioning is assured by two preinstalled plates which ensure that the angle head adheres to the support surface of the tool supporting plate.



9. Cutting parameters:

A CC type cutting machine, having the correct cutting parameters and the proper saw blade, guarantees a quality cut.

- There are two cutting parameters.
- The rotation speed of the cutting tool (RPM), expressed as revolutions per minute.
 - The speed with which the tool advances (A), expressed in meters per minute.

RPM can be regulated either with the variable speed control on the electric cutting motors or by varying the input air pressure on a pneumatic motor. Consult the table on page 3. The speed with which the tool advances (A) is controlled by the operator by adjusting the rotation speed of the advance crank handle, or can be automated with an electric or pneumatic motor (consult the accessories catalogue).

Rotation Speed RPM:

The rotation speed RPM is found using the formula:

$$RPM = (1000 \times Vc) / (3.14 \times D)$$

Vc = the tool's cutting speed in m/min
D = the tool's diameter in mm

Hardness of the material in kg/mm ²	Vc in m/min
From 0 to 50 (carbon steel)	From 25 to 35
From 50 to 110 (carbon/stainless steel)	From 18 to 25
Over 110 (Stainless steel)	From 12 to 18

For our application, the speed ranges used are:

Cutting tool	0 to 50 kg/mm ²	50 to 110 kg/mm ²	> 110 kg/mm ²
	Rotation speed in rot/min		
LS63128			
LS63100	125 to 180	90 to 125	60 to 90
LS6364			
LS6872	120 to 165	85 to 120	55 to 85
LS6844			
LS8080			
LS8054	100 to 140	70 to 90	45 to 70
LS8034			
LS9038	90 to 125	65 to 90	40 to 65

For the motor's rotation speed refer to page 3.

Advancement speed A:

The advancement speed is found with the formula:

$$A = Az \times Z \times RPM$$

A = advancement speed in mm/min

Az = advancement speed by tool teeth in mm

Z = number of tool teeth

RPM = Cutting tool rotation speed in rot/min

Hardness of the material in kg/mm ²	Az in mm	
	LS63100 LS6364 LS6872 LS6844	LS63128 LS8080 LS8054 LS8034 LS9038
From 0 to 50	0.06 to 0.1	0.03 to 0.06
From 50 to 110	0.03 to 0.06	0.02 to 0.04
> 110	0.02 to 0.05	0.01 to 0.03

Common Parameters:

Material	Tube dimension	Cutting tool	RPM	Cutting time	Lubrication
STAINLESS STEEL 60 kg/mm ²	60.3x0.5	LS63128	90 rpm	1 min	NO
STAINLESS STEEL 60 kg/mm ²	60.3x2.0	LS6872	90 rpm	30 s	NO
STAINLESS STEEL 60 kg/mm ²	60.3x15.0	LS9038	50 rpm	4 min	YES
STAINLESS STEEL 60 kg/mm ²	168.3x5.0	LS6844	90 rpm	3 min	YES
STAINLESS STEEL 60 kg/mm ²	323.9x8.0	LS9038	60 rpm	3 min	YES
STAINLESS STEEL 60 kg/mm ²	88.9x2.77	LS6844	140 rpm	30 s	NO
Steel 30 kg/mm ²	88.9x10.0	LS8034	90 rpm	1.5min	YES
Steel 30 kg/mm ²	323.9x8.0	LS9038	90 rpm	5 min	YES

10. The tube's fastening:

Warning: It is extremely important, so that the machine will not be damaged, to support the tube both in front and behind when it extends beyond the machine for more than 500 mm or if there is an overhang weighing more than 25 kg.

Good alignment between the fastening of the tube and the machine guarantees the cut's perpendicularity.

The alignment between the cutting machine and the fastening system for the cut tube avoids pinching the tool and therefore guarantees its longevity.



11. Additional clamping jaws:

In order to increase the tightening capacity of the cutting machines, additional clamping jaws are provided included.

Cutting Machine	Machine capacity in mm		
	Basic clamping jaws	Additional clamping jaws 1	Additional clamping jaws 2
CC121	24 to 129 mm	5 to 108 mm	/
CC171	70 to 129 mm	16 to 118 mm	/
CC221	116 to 225 mm	58 to 172 mm	/
CC321	257 to 330 mm	197 to 270 mm	138 to 210 mm

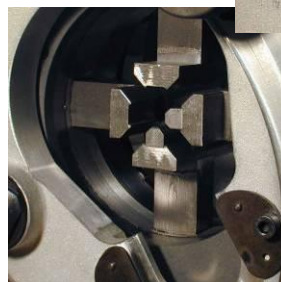

12. Penetration adjustments:

- Put the blade in its working position. The index plunger of the penetration lever in the screw head on the steel plate (Fig.01).
- Move the tube forward to the edge of the clamping jaws so that it is slightly back in relation to the tool. Clamp the tube to ensure a good geometry of the adjustments (Fig.02).
- Loosen the knurled screw of the penetration lever (Fig.03) and swivel the tool support plate (Fig.04) so that the top teeth of the cutting tool protrude from 1 to 2 mm into the interior of the tube (Fig.05).
- Retighten the knurled screw of the penetration lever (Fig.03) when the adjustments are done.
- Lift back up the penetration lever to disengage the cutting tool (Fig.06).
- **This adjustment is necessary each time you change tube diameter and/or thickness.**



Fig.01



Fig.02



Fig.03



Fig.04



Fig.05



Fig.06

13. Cutting step by step:

Warning: Always check that the tube does not bump up against the saw blade when it is put into the cutting machine and that it is correctly aligned with the cutting machine.
Before starting the cutting motor, make sure that there are no foreign bodies left in the cutting area.

- Tightening the hold on the tube (1).
- Starting the cutting motor (2).
- Penetration into the tube (3).
- Rotating around the tube (4).
- Disengaging from the tool after the cut is made (3).
- Stopping the cutting motor (2)
- Loosening the hold on the tube.

The cut is finished.

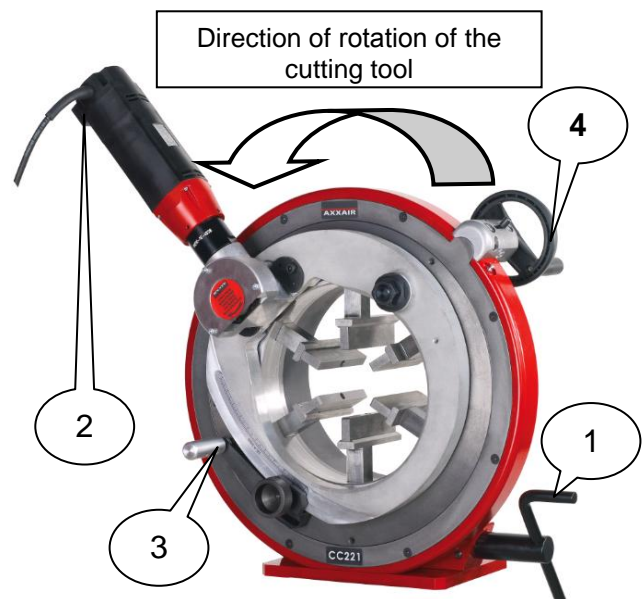

14. Lubricants:

Warning: Take particular care when using a liquid lubricant on the electric cutting motor. Electric motors are not watertight and any contact with a liquid risks causing damage to the motor and putting **the user's safety at risk.**

AXXAIR offers two types of lubricants made for cutting purposes: cutting oil Ref. CCLUH and the cutting paste Ref. CCLUP.



15. Maintenance and Repairs:

- Maintenance operations should be done by qualified personnel using original replacement parts.
- Before starting, it is necessary to disconnect all power supplies.
- The machine and its accessories should always be stored and transported in their original packaging.
- It is essential to keep the machine clean in order to optimize its performance.
- The machine should be cleaned with the aid of the brush provided in the bag and lubricated after each usage.
- Don't leave the machine in a detrimental, dirty, or humid environment.

It is essential that foreign bodies not be placed in the swivelling system of the machine. It is recommended that the brush provided be used to clean the machine.

Never clean with pressurized air.

Clean thoroughly and check that there are no cuttings before doing any work on the machine. We recommend a disassembly and lubrication of moving parts by qualified personnel every year. *We offer a flat-rate maintenance contract with our workshops. For more information contact us.*

Changing the vanes in pneumatic cutting motors:

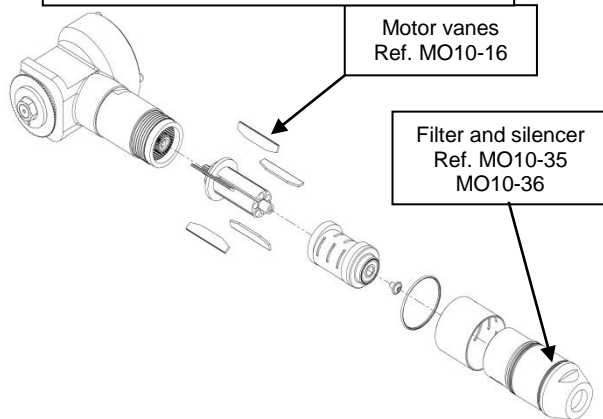

Changing the carbon contacts in electric cutting motors:

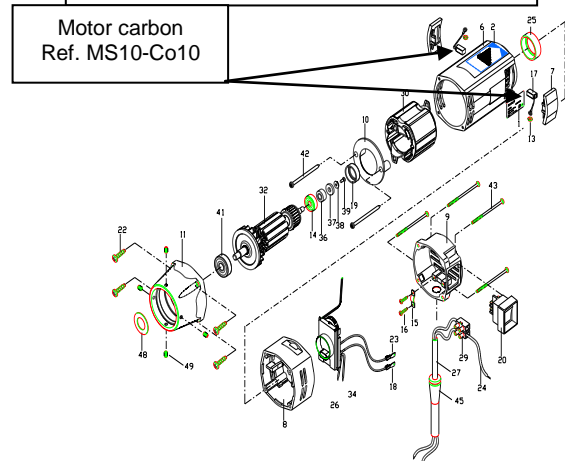

16. Environmental protection

AXXAIR packaging is 100% recyclable. Used mechanical parts and electrical equipment contain large quantities of valuable raw materials that can be also sent for recycling.

For European countries only: Do not deposit electrical equipment in household waste! In pursuance of European directive 2002/96/CE on recovery and recycling of waste electrical and electronic equipment (WEEE), and its translation into national legislation, electrical apparatus must be collected separately and undergo environmentally-friendly recycling.